

CMI PUBLIC SCHOOL, CHALAKUDY
CBSE CLUSTER- X (U-17 & 19) FOOTBALL TOURNAMENT 2018-19

RULES & REGULATIONS

1. The tournament will be held from October 3rd to 10th 2018 (U-17 first).
2. There will be more than one game one day.
3. 11 + 5 = 16 players can be registered in one team.
4. The team should report 45 minutes before the match.
5. The decision of the Referee is final.
7. All the players should wear proper uniform with number.
8. The tournament will be conducted on knock out basis.
9. Outstation teams are requested to inform the travel plan in advance to enable us to make necessary arrangements regarding pick up.
(Contact No: Mr. AUGUSTINE 9349847996, Mr. JIMMY - 9946350033),

IMPORTANT: IT SHALL BE MANDATORY FOR ALL THE PARTICIPATING SCHOOLS TO PROVIDE THE FOLLOWING ON ARRIVAL AT VENUE

- (i) The documents for verification in original if asked for.
- (ii) The team photo with school Principal along with the entry Performa, countersigned by the concerned Principal.
- (iii) To supply the print out of eligibility performa filled-in online, countersigned by the concerned Principal.

Please contact for accommodation:-

- | | |
|-----------------------------|--------------------------------|
| 1. Chunganth Tourist Home | – Ph: 0480 2702560 |
| 2. ACE Tourist Home | – Ph: 9048592072 (Abhilash) |
| 3. Kokkattil Lodge | – Ph: 0480 2700208, 8281102208 |
| 4. Premier Lodge | – Ph: 9895313238, 9846855408 |
| 5. Bombay Tourist Home | – Ph: 0480 2707280, 9605274631 |
| 6. New Hillway Tourist Home | – Ph: 0480 2701549, 2703713 |
| 7. Jeevan Tourist Home | – Ph: 9388519572, 9747903903 |

PRINCIPAL

CMI Public School, Chalakudy

Office No: 0480- 2706330

CLUSTER – X UNDER – 17 CBSE FOOTBALL TOURNAMENT 2018

POOL – A

FIXTURE

POOL – C

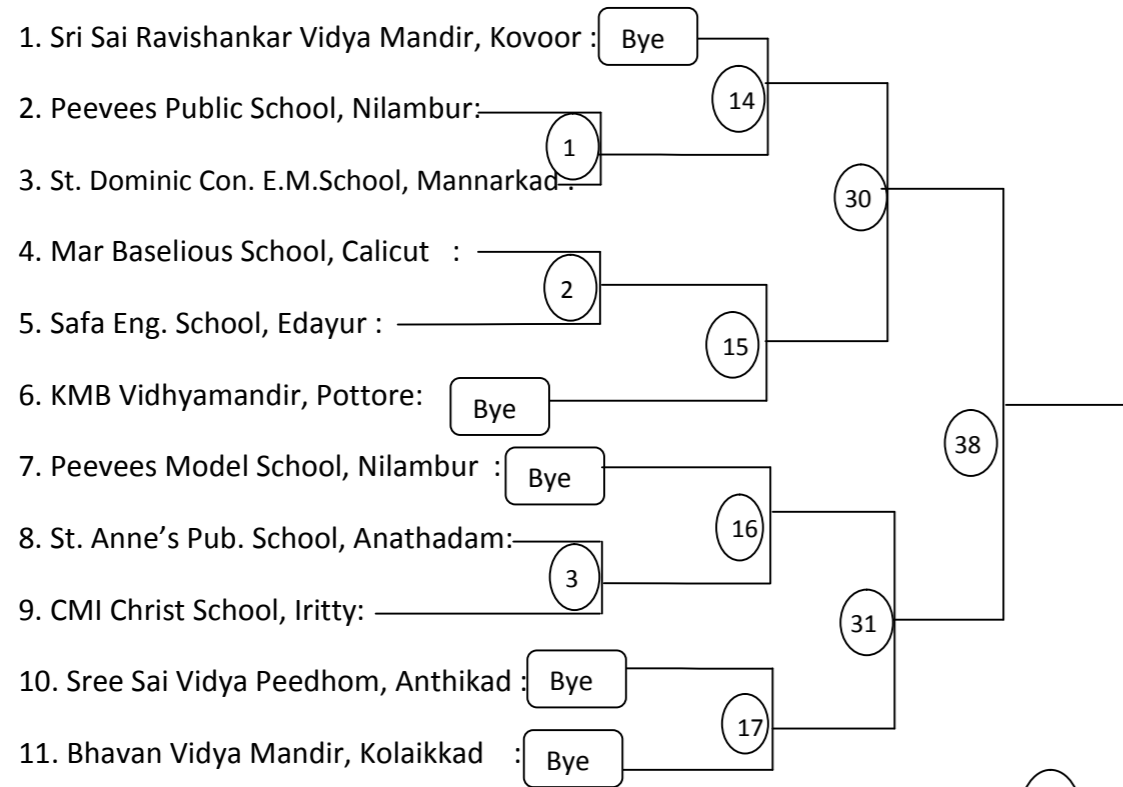

POOL – B

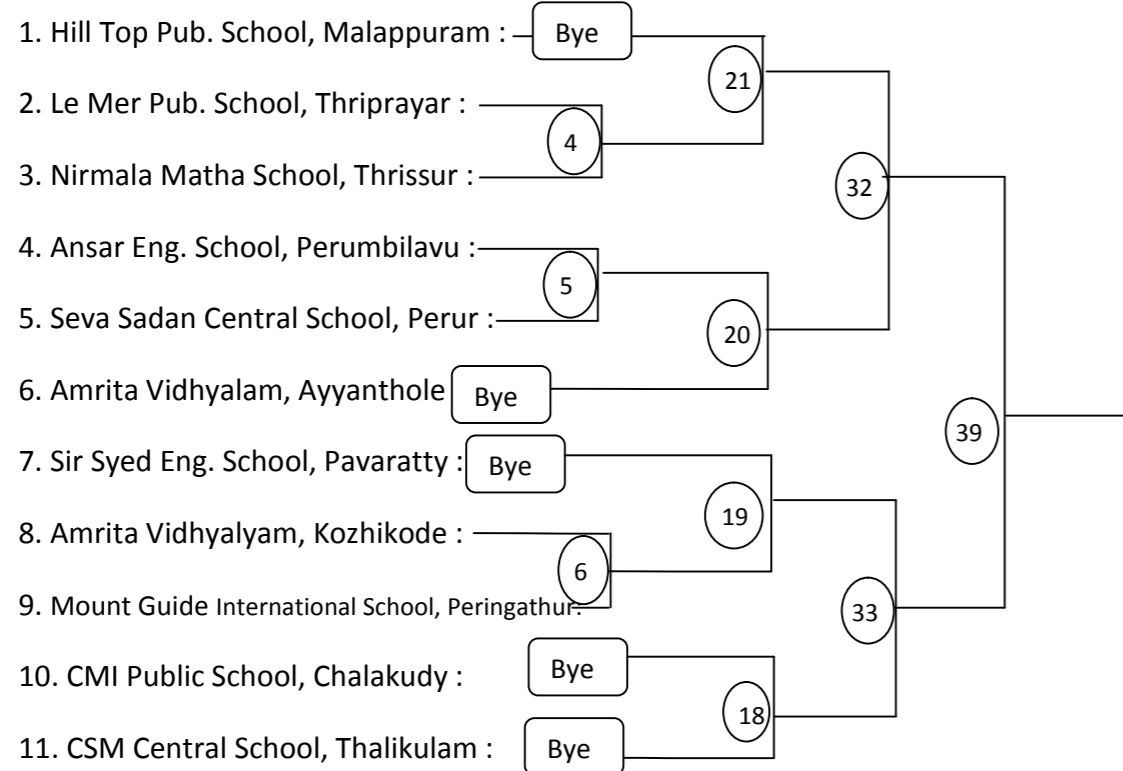

POOL – D

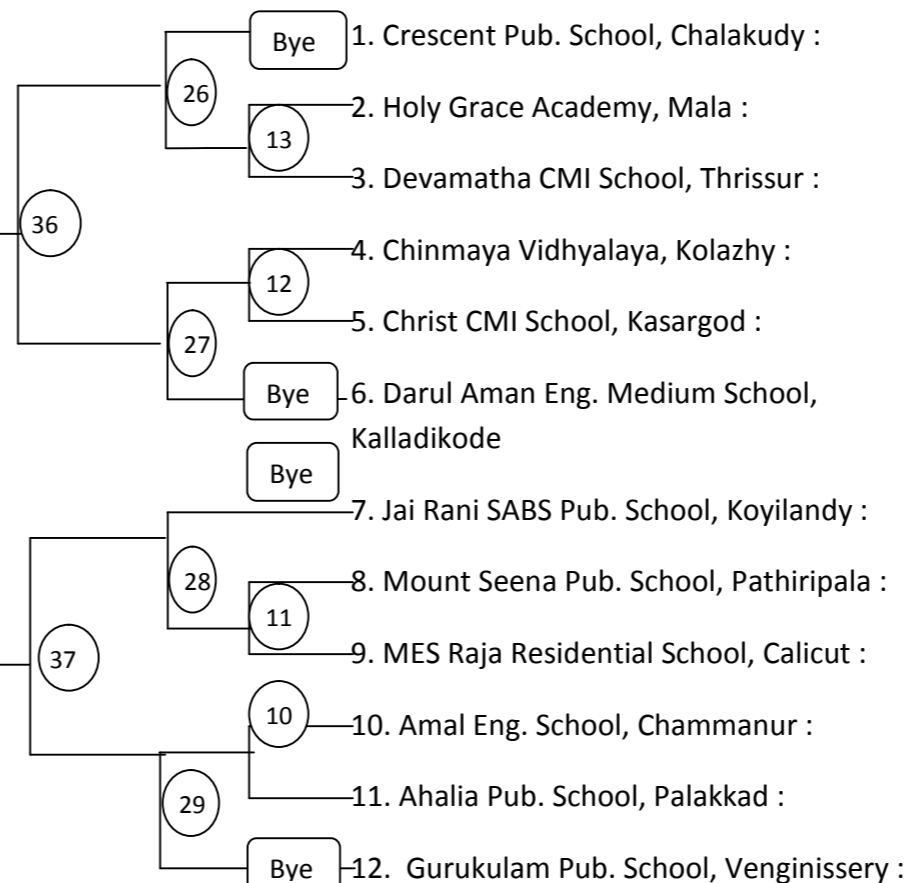

GROUND: CMI G-1		
Match No:	Date	Time
1	3/10/2018	07:30 a.m.
2		08:30 a.m.
3		10:00 a.m.
4		11:00 a.m.
5		12:00 p.m.
6		02:00p.m.
7		03:00 p.m.
8		04:00 p.m.
9		05:00 p.m.
10		06:00 p.m.
11	4/10/2018	07:30 a.m.
12		08:30 a.m.
13		09:30 a.m.
14		10:30 a.m.
15		11:30 a.m.
16		01:30 p.m.
17		02:30p.m.
18		03:30 p.m.
19		04:30 p.m.
20		05:30 p.m.
21	5/10/2018	07:30 a.m.
22		08:30 a.m.
23		09:30 a.m.
24		10:30 a.m.
25		11:30 a.m.
26		01:30 p.m.
27		02:30p.m.
28		03:30 p.m.
29		04:30 p.m.
30		05:30 p.m.
31	6/10/2018	07:30 a.m.
32		08:30 a.m.
33		09:30 a.m.
34		10:30 a.m.
35		11:30 a.m.
36		01:30 p.m.
37		02:30p.m.
39		04:30 p.m.
40		05:30 p.m.
41	7/10/2018	07:30 a.m.
42		04:30 p.m.
43		05:30 p.m.
44	8/10/2018	07:30 a.m.

GROUND: Carmel HS		
38	6/10/2018	03:30 p.m.

CLUSTER – X [UNDER – 19] CBSE FOOTBALL TOURNAMENT 2018 FIXTURE

POOL – A

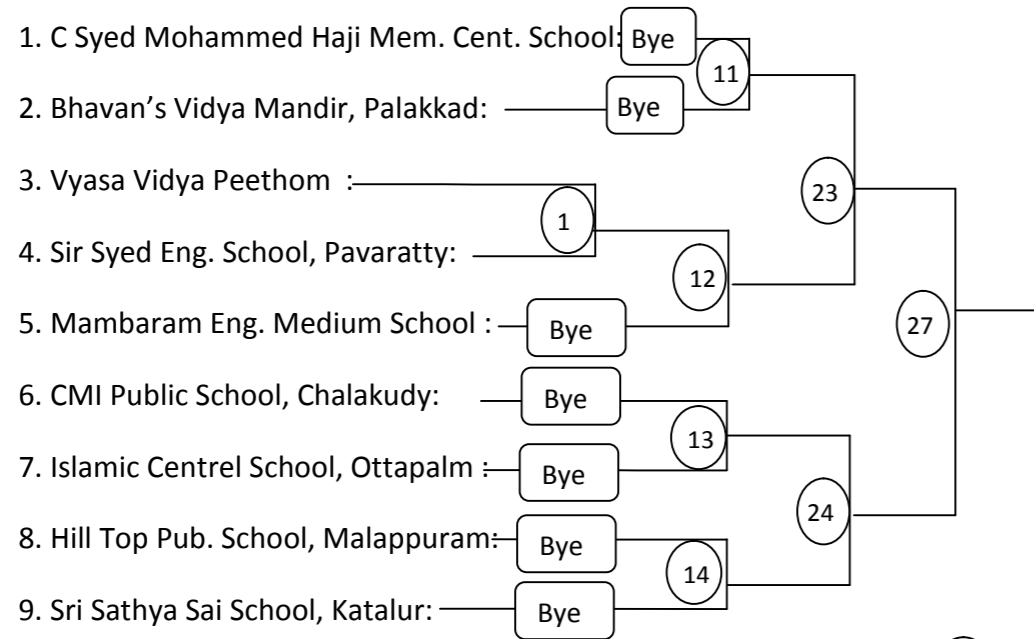

POOL – B

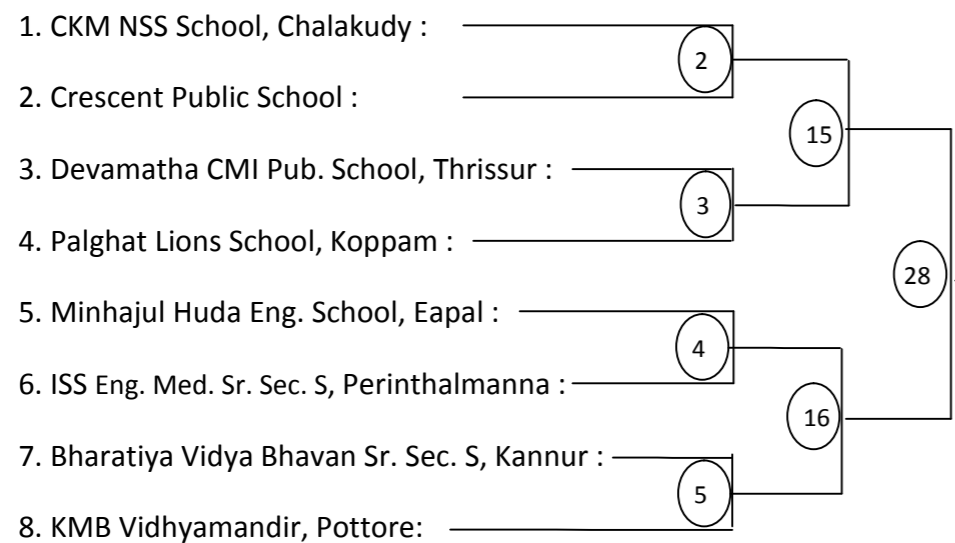

POOL – C

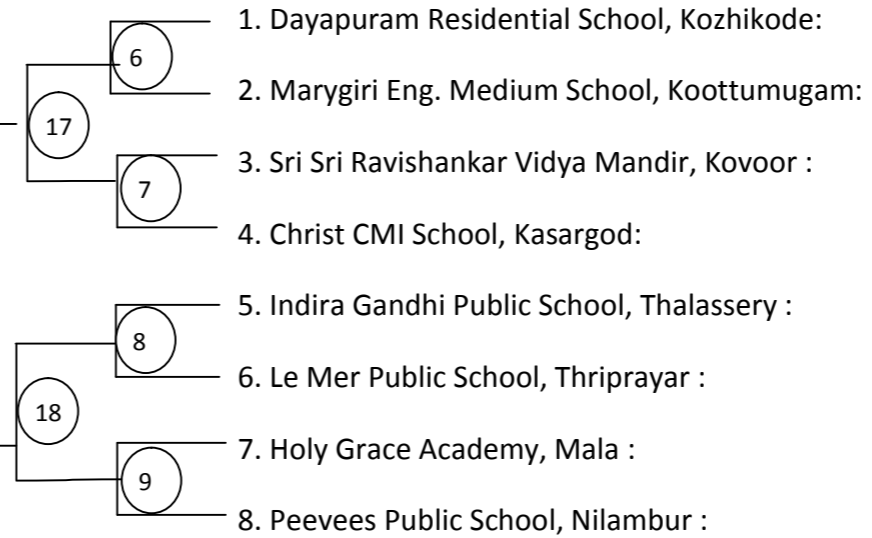

POOL – D

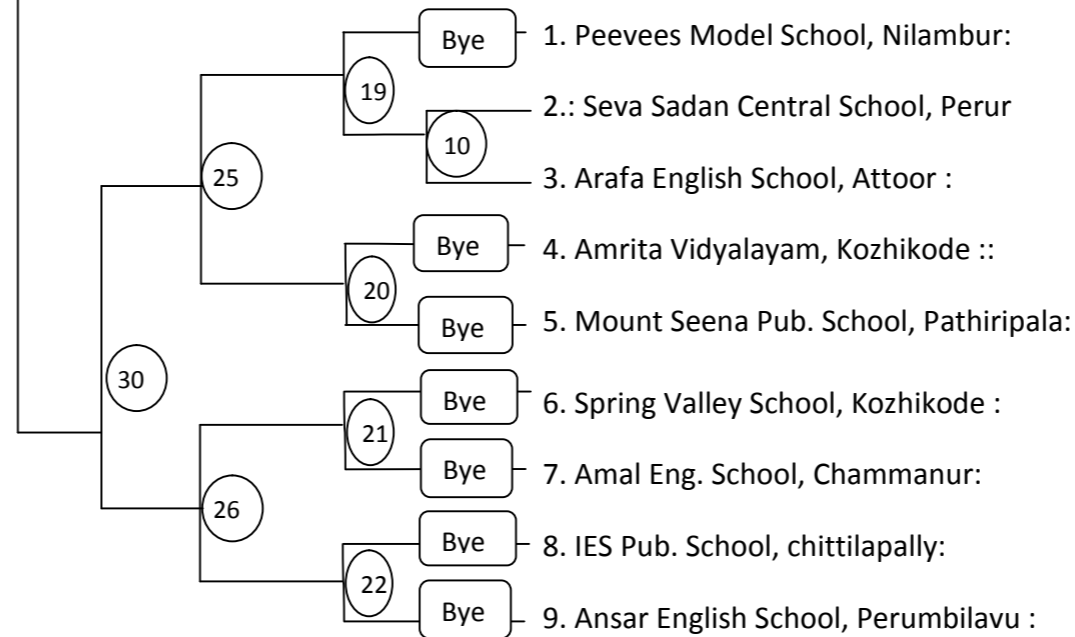

33
F I N A L

31
SEMI - I

32
SEMI - II

GROUND: CMI G- 1		
Match No:	Date	Time
1	7/10/2018	08:30 a.m.
2		09:30 a.m.
3		10:30 a.m.
4		11:30 a.m.
5		01:30 p.m.
6		02:30p.m.
7		03:30 p.m.
8	8/10/2018	08:30 a.m.
9		09:30 a.m.
10		10:30 a.m.
11		11:30 a.m.
12		01:30 p.m.
13		02:30p.m.
14		03:30 p.m.
15		04:30 p.m.
16		05:30 p.m.
21	9/10/2018	11:30 a.m.
22		01:30 p.m.
23		02:30p.m.
26		05:30 p.m.
27	10/10/2018	07:30 a.m.
28		08:30 a.m.
29		09:30 a.m.
30		10:30 a.m.
31		03:30 p.m.
32		04:30 p.m.
33	11/10/2018	08:00 a.m.

GROUND: CARMEL H.S.		
17	9/10/2018	07:30 a.m.
18		08:30 a.m.
19		09:30 a.m.
20		10:30 a.m.
24		03:30 p.m.
25		04:30 p.m.

CMI PUBLIC SCHOOL, CHALAKUDY
CBSE CLUSTER- XI (U-17 & 19) FOOTBALL TOURNAMENT 2018-19

RULES & REGULATIONS

1. The Tournament will be held from October 3rd to 10th 2018 (U-17 first).
2. There will be more than one game one day.
3. The team has to check with the fixture about the venue and to report to the there .
4. The team should report 45 minutes before the match.
5. 11 + 5 = 16 players can be registered in one team.
6. The decision of the Referee is final.
7. All the players should wear proper uniform with number.
8. The Tournament will be conducted on knock out basis.
9. Outstation teams are requested to inform the travel plan in advance to enable us to make necessary arrangements regarding pick up.
(Contact No: Mr. AUGUSTINE - 9349847996, Mr. JIMMY - 9946350033).

IMPORTANT: IT SHALL BE MANDATORY FOR ALL THE PARTICIPATING SCHOOLS TO PROVIDE THE FOLLOWING ON ARRIVAL AT VENUE

- (i) The documents for verification in original if asked for.
- (ii) The team photo with school Principal along with the entry Performa, countersigned by the concerned Principal.
- (iii) To supply the print out of eligibility performa filled-in online, countersigned by the concerned Principal.

Please contact for accommodation:-

- | | |
|-----------------------------|--------------------------------|
| 1. Chunganth Tourist Home | – Ph: 0480 2702560 |
| 2. ACE Tourist Home | – Ph: 9048592072 (Abhilash) |
| 3. Kokkattil Lodge | – Ph: 0480 2700208, 8281102208 |
| 4. Premier Lodge | – Ph: 9895313238, 9846855408 |
| 5. Bombay Tourist Home | – Ph: 0480 2707280, 9605274631 |
| 6. New Hillway Tourist Home | – Ph: 0480 2701549, 2703713 |
| 7. Jeevan Tourist Home | – Ph: 9388519572, 9747903903 |
| 8. Thasnim Tourist Home | – Ph: 9539324593 |
| 9. Bavana Tourist Home | – Ph : 7561824399 |
| 10. City Lodge | – Ph: 9496126462 |

PRINCIPAL

CMI Public School, Chalakudy

Office No: 0480- 2706330

CLUSTER - XI [UNDER - 19] CBSE FOOTBALL TOURNAMENT 2018

FIXTURE

QUARTER FINALS

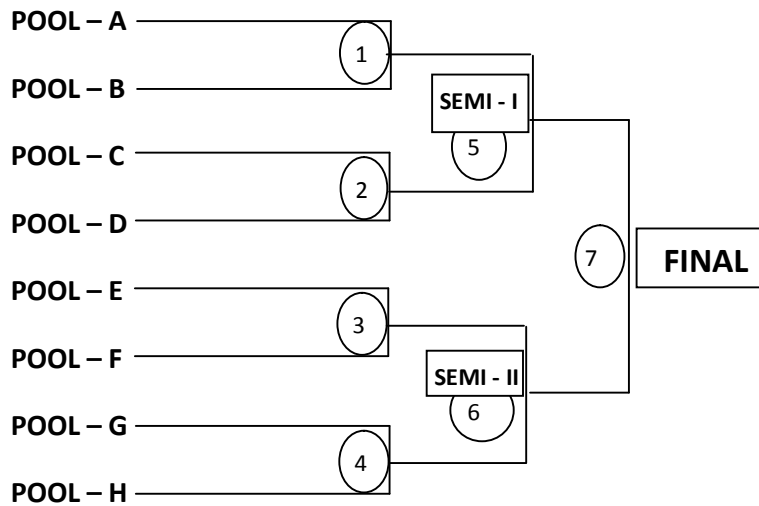

CMI PUB. SCHOOL, CHALAKUDY		
GROUND : 1		
Match No:	Date	Time
1	9/10/2018	07:30 a.m.
2		08:30 a.m.
3		09:30 a.m.
4		10:30 a.m.
SEMI FINALS		
5		04:00 p.m.
6		05:00 p.m.
FINAL		
7	10/10/2018	10:00 a.m.

CLUSTER - XI [UNDER - 19] CBSE FOOTBALL TOURNAMENT 2018

FIXTURE

POOL - A

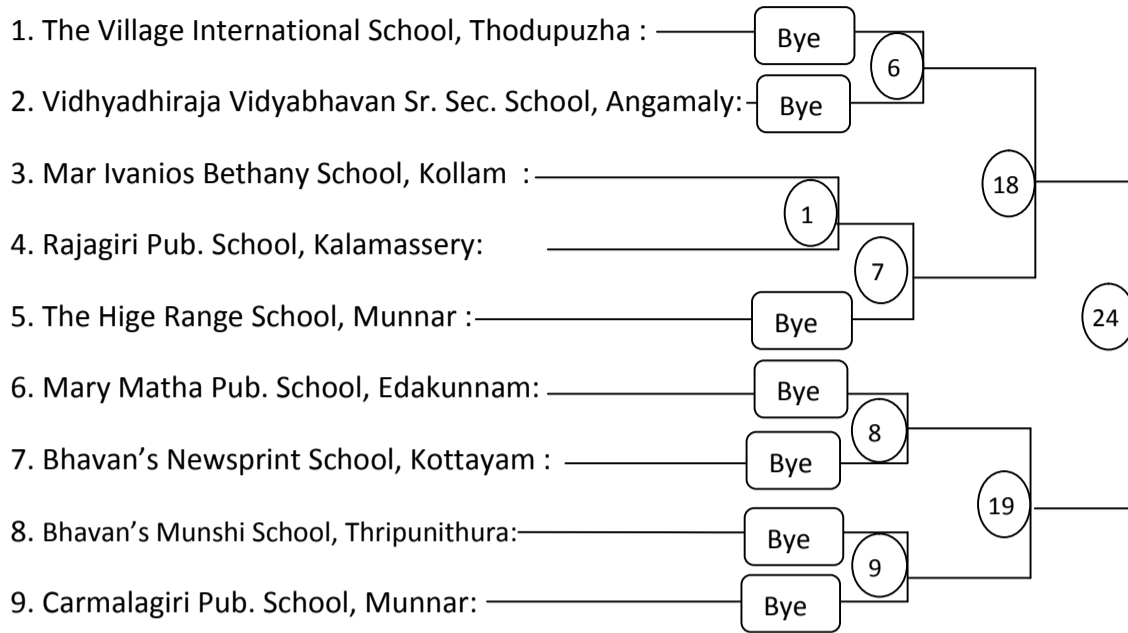

GROUND :		
BVM HS, KALLETUMKARA, IRINJALAKUDA		
Match No:	Date	Time
1	4/10/2018	02:00p.m.
2		03:00 p.m.
3		04:00 p.m.
4		05:00 p.m.
5	5/10/2018	07:30 a.m.
6		08:30 a.m.
7		09:30 a.m.
8		10:30 a.m.
9		11.30 a.m.
10		01:30 p.m.
11		02:30p.m.
12		03:30 p.m.
13	6/10/2018	04:30 p.m.
14		05:30 p.m.
15		07:30 a.m.
16		08:30 a.m.
17		09:30 a.m.
18		10:30 a.m.
19		11.30 a.m.
20		01:30 p.m.
21		02:30p.m.
22		03:30 p.m.
23		04:30 p.m.
24		05:30 p.m.
25	7/10/2018	07:30 a.m.
26		08:30 a.m.

POOL - B

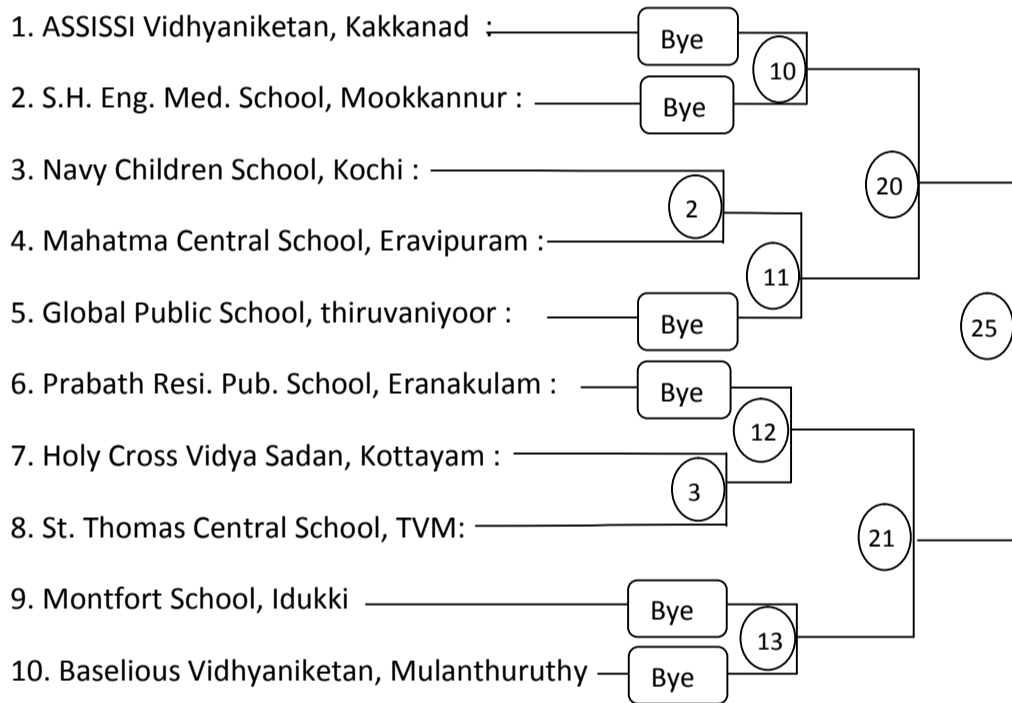

POOL - C

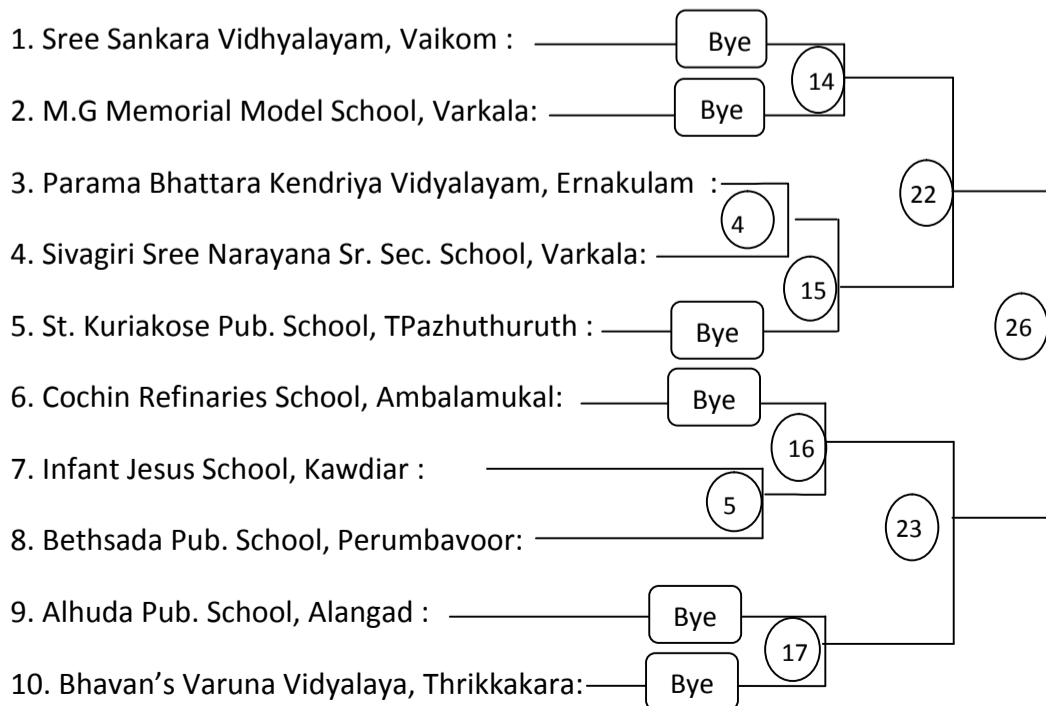

CLUSTER - XI [UNDER - 19] CBSE FOOTBALL TOURNAMENT 2018 FIXTURE

POOL - D

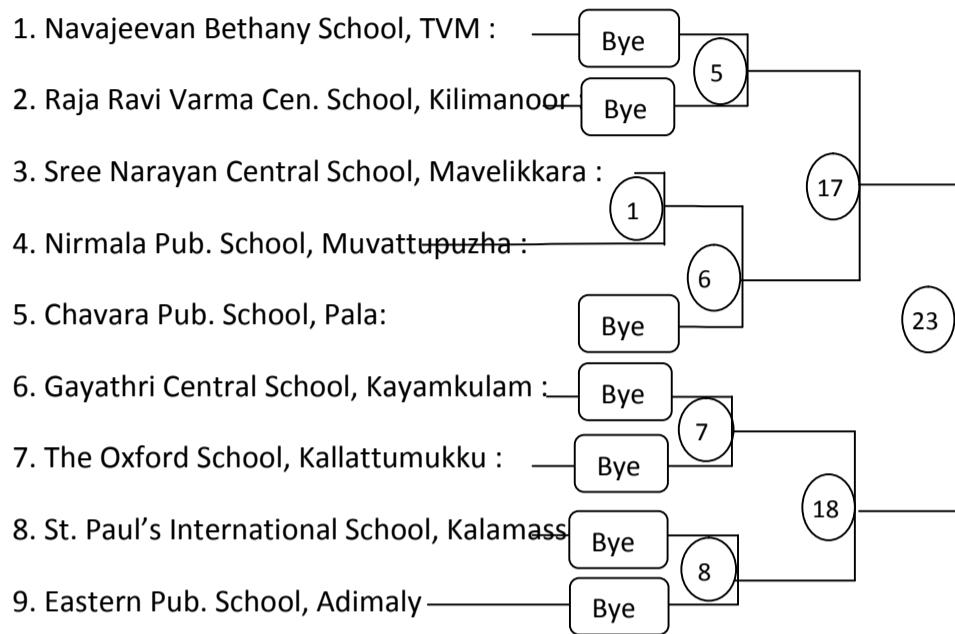

POOL - E

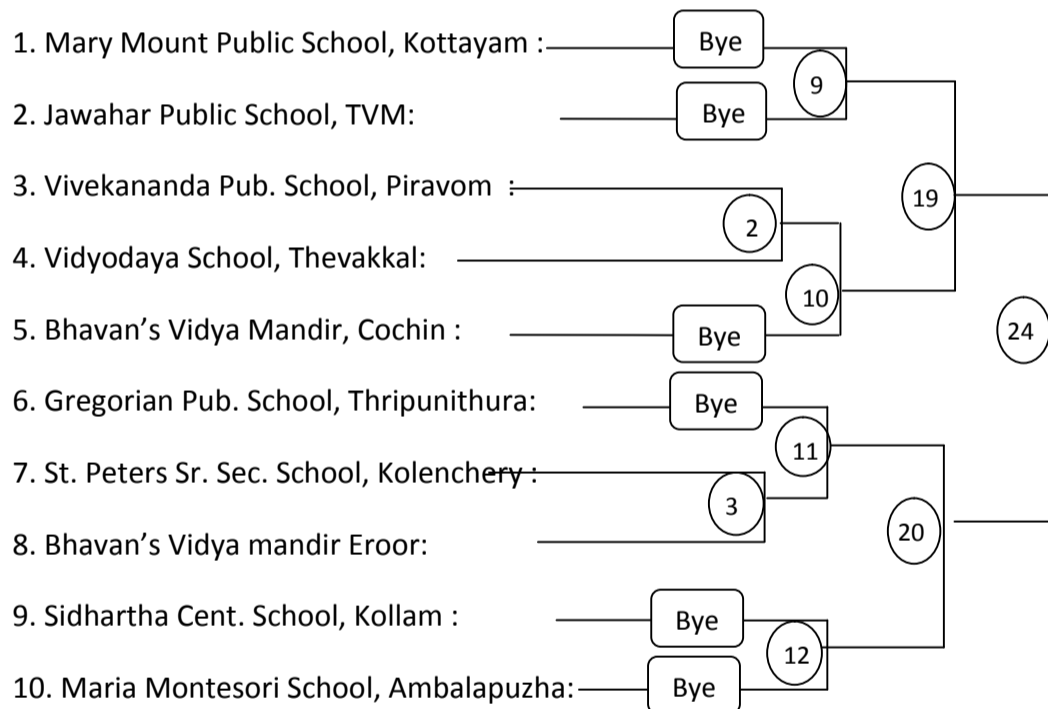

POOL - F

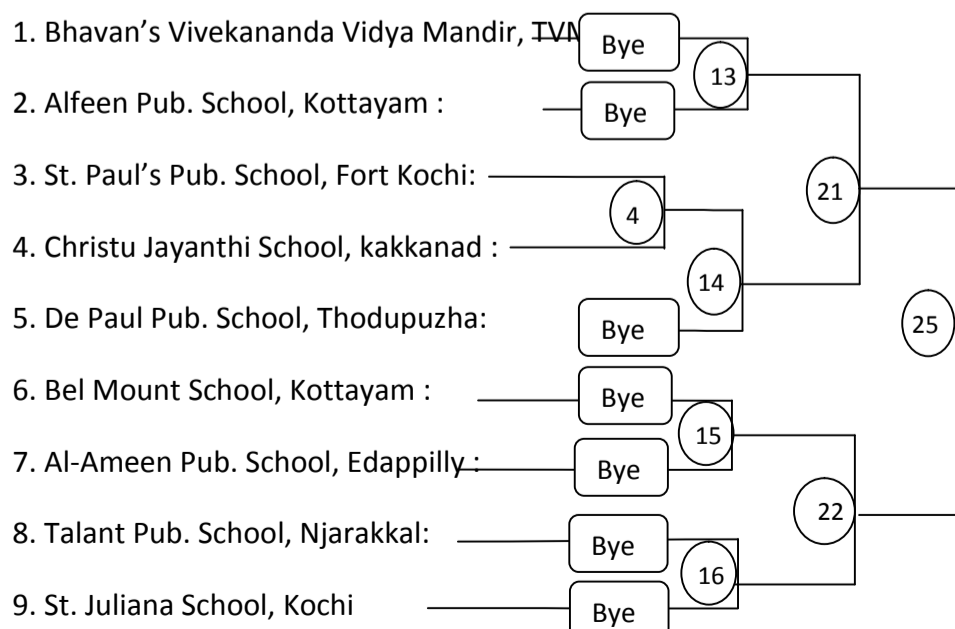

GROUND :		
CARMEL HS, CHALAKUDY		
Match No:	Date	Time
1	5/10/2018	10:00 a.m.
2		11:00 a.m.
3		12:00 p.m.
4		02:00p.m.
5		03:00 p.m.
6		04:00 p.m.
7		05:00 p.m.
8	6/10/2018	07:30 a.m.
9		08:30 a.m.
10		09:30 a.m.
11		10:30 a.m.
12		11:30 a.m.
13		01:30 p.m.
14		02:30p.m.
17	7/10/2018	05:30 p.m.
18		07:30 a.m.
19		08:30 a.m.
20		09:30 a.m.
21		10:30 a.m.
22		11:30 a.m.
23		01:30 p.m.
24		02:30p.m.
25	03:30 p.m.	

GROUND : CMI PUB. SCHOOL G - 2		
15	6/10/2018	03:30 p.m.
16		04:30 p.m.

CLUSTER - XI [UNDER - 19] CBSE FOOTBALL TOURNAMENT 2018

FIXTURE

POOL - G

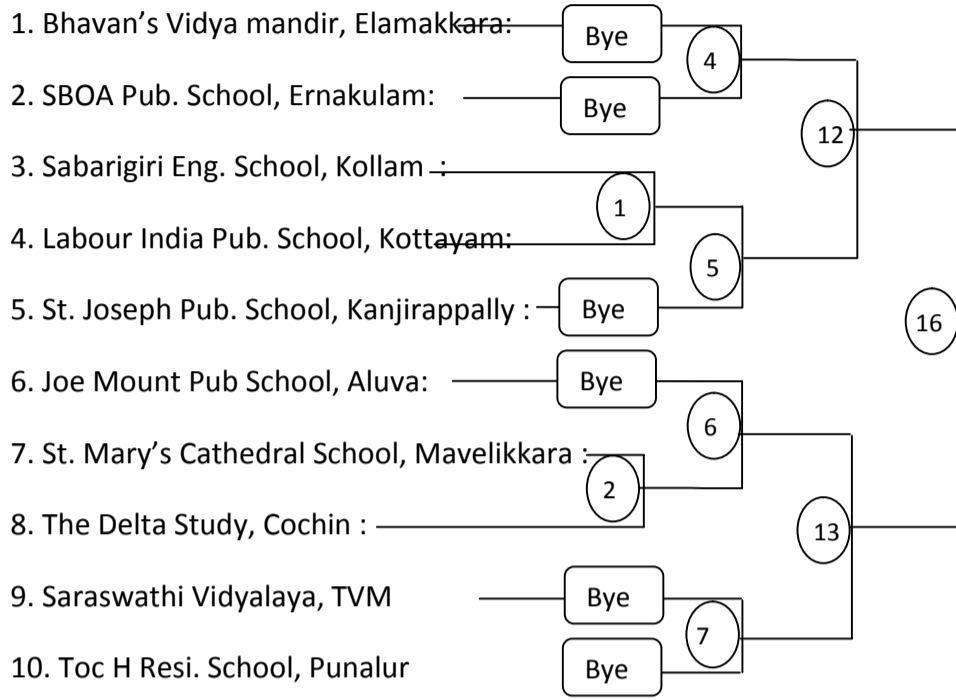

GROUND :		
CMI PUB. SCHOOL, CHALAKUDY GROUND - 2		
Match No:	Date	Time
1	7/10/2018	07:30 a.m.
2		08:30 a.m.
3		11:30 a.m.
4		01:30 p.m.
5		02:30p.m.
6		03:30 p.m.
7		04:30 p.m.
8		05:30 p.m.
9	8/10/2018	07:30 a.m.
10		08:30 a.m.
11		09:30 a.m.
12		10:30 a.m.
13		11:30 a.m.
14		01:30 p.m.
15		02:30p.m.
16		03:30 p.m.
17		05:30 p.m.

POOL - H

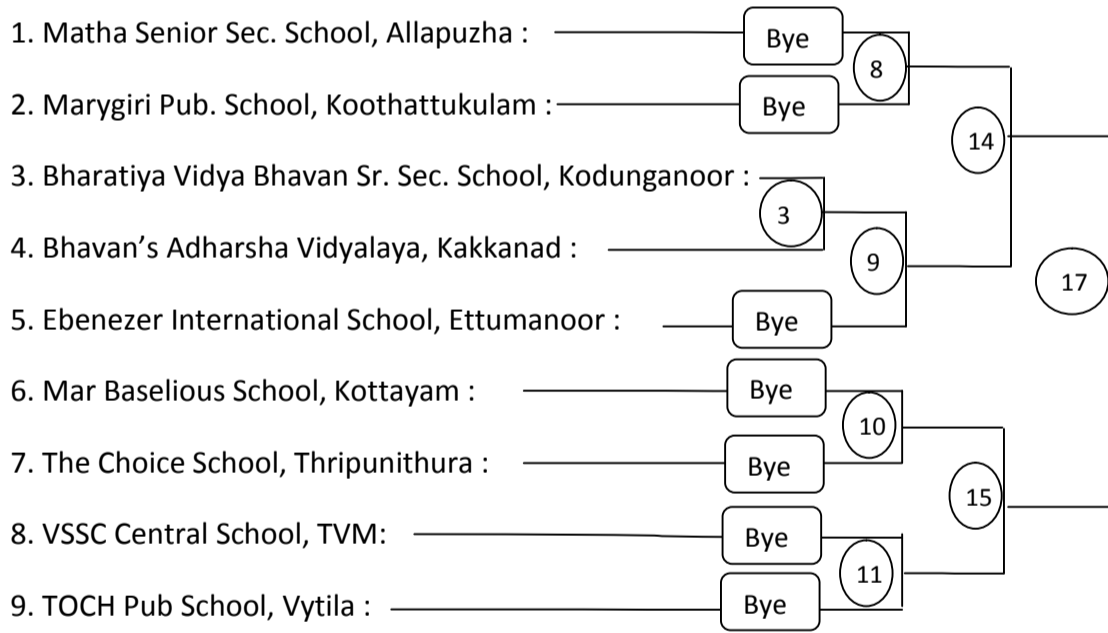

CLUSTER - XI [UNDER - 17] CBSE FOOTBALL TOURNAMENT 2018

FIXTURE

QUARTER FINALS

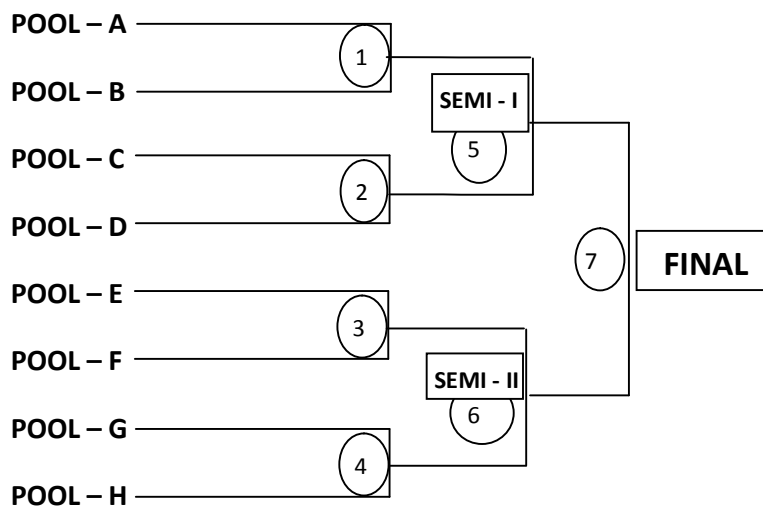

CMI PUB. SCHOOL, CHALAKUDY		
GROUND : 1		
Match No:	Date	Time
1	6/10/2018	07:30 a.m.
2		08:30 a.m.
3		09:30 a.m.
4		10:30 a.m.
SEMI FINALS		
5		02:30 p.m.
6		03:30 p.m.
FINAL		
7	7/10/2018	09:30 a.m.

CLUSTER - XI [UNDER - 17] CBSE FOOTBALL TOURNAMENT 2018

FIXTURE

POOL – A

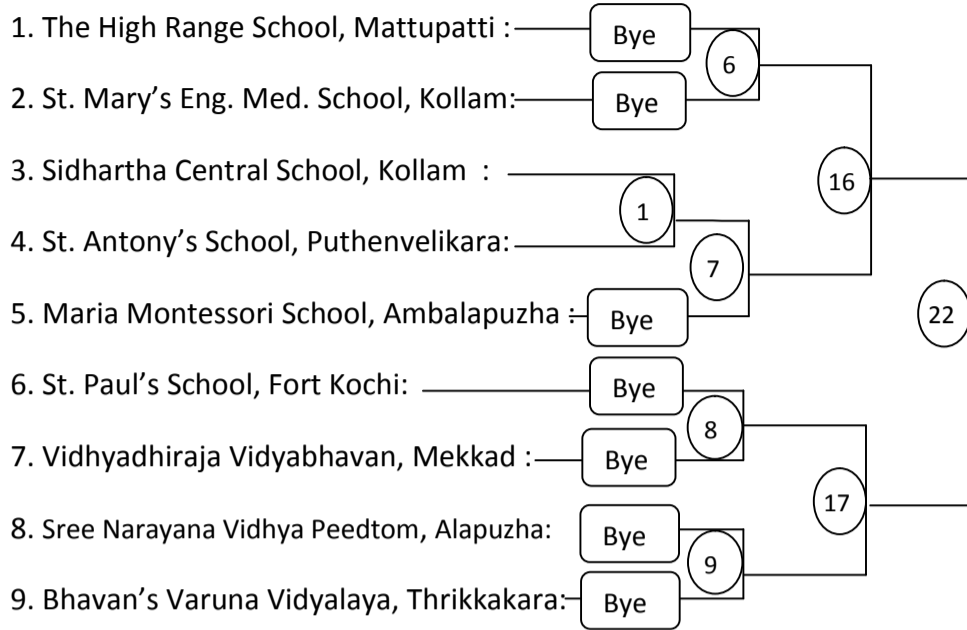

POOL – B

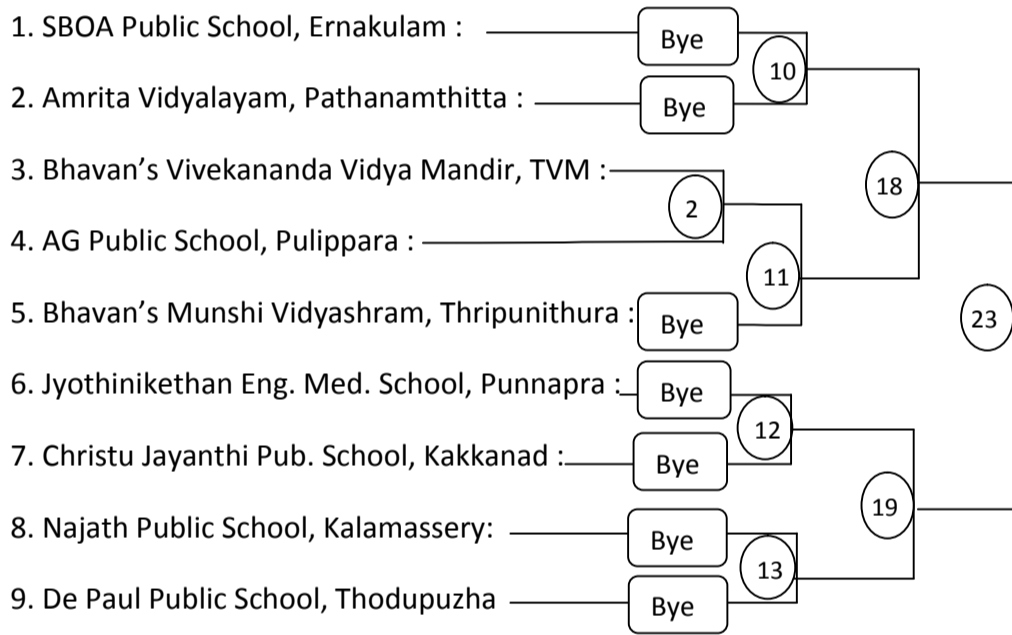

POOL – C

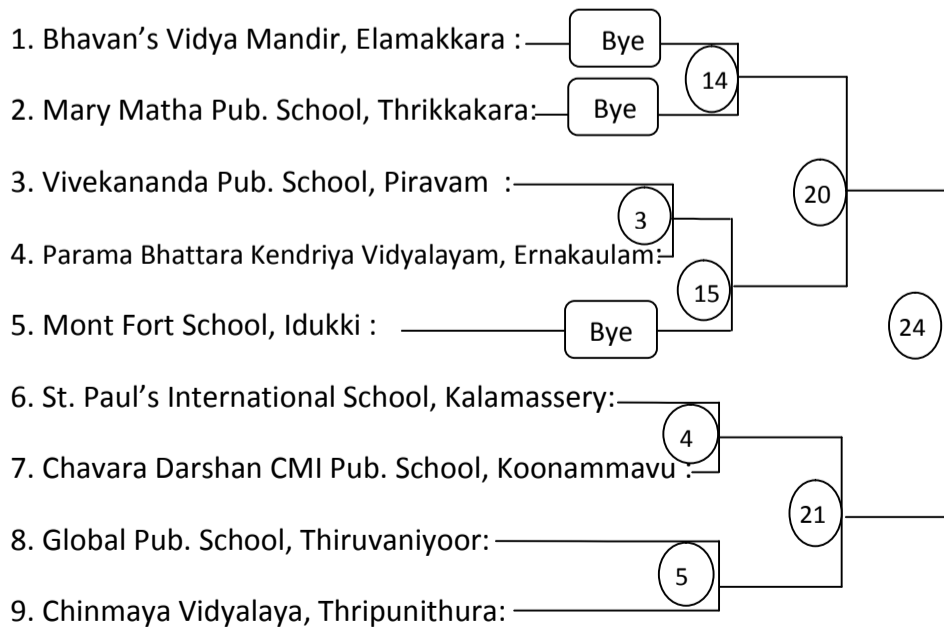

GROUND:		
CMI PUB. SCHOOL, CHALAKUDY GROUND 2		
Match No:	Date	Time
1	3/10/2018	07:30 a.m.
2		08:30 a.m.
3		10:00 a.m.
4		11:00 a.m.
5		12:00 p.m.
6		02:00p.m.
7		03:00 p.m.
8		04:00 p.m.
9		05:00 p.m.
10		06:00 p.m.
11	4/10/2018	07:30 a.m.
12		08:30 a.m.
13		09:30 a.m.
14		10:30 a.m.
15		11:30 a.m.
16		01:30 p.m.
17		02:30p.m.
18		03:30 p.m.
19		04:30 p.m.
20		05:30 p.m.
21	5/10/2018	07:30 a.m.
22		08:30 a.m.
23		09:30 a.m.
24		11:30 a.m.

CLUSTER - XI [UNDER - 17] CBSE FOOTBALL TOURNAMENT 2018

FIXTURE

POOL - D

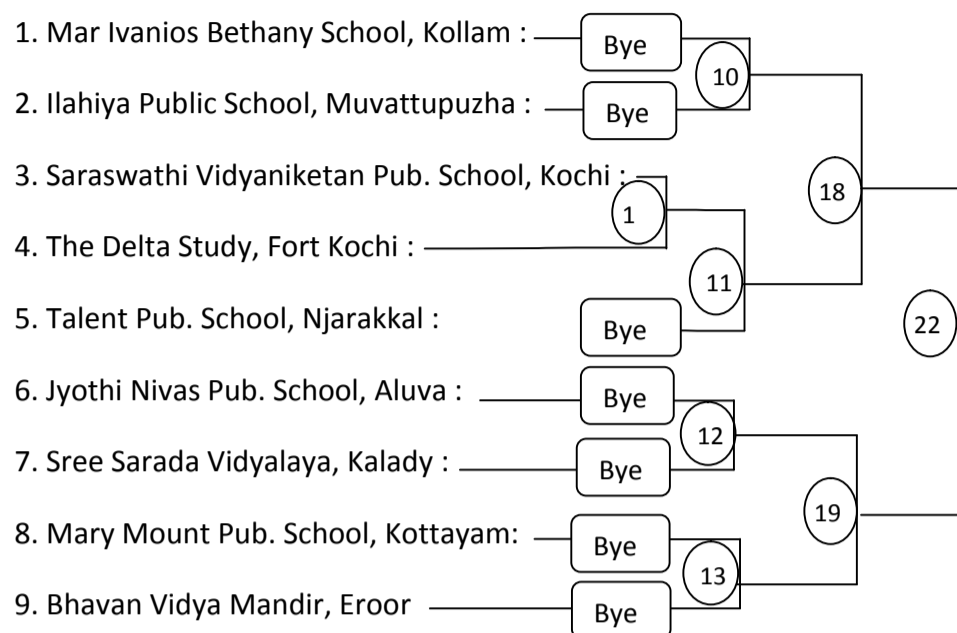

POOL - E

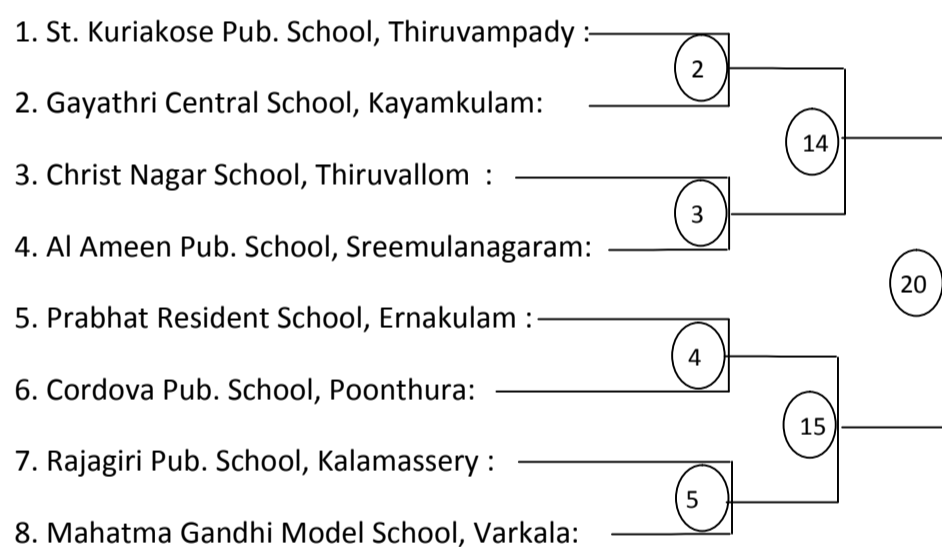

POOL - F

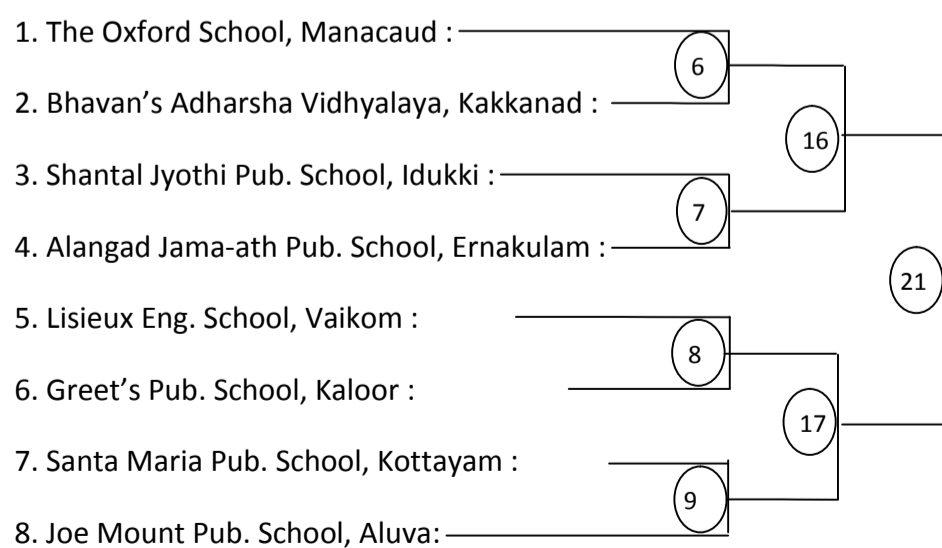

GROUND:		
CARMEL HS, CHALAKUDY		
Match No:	Date	Time
1	3/10/2018	07:30 a.m.
2		08:30 a.m.
3		10:00 a.m.
4		11:00 a.m.
5		12:00 p.m.
6		02:00p.m.
7		03:00 p.m.
8		04:00 p.m.
9		05:00 p.m.
10		06:00 p.m.
11	4/10/2018	07:30 a.m.
12		08:30 a.m.
13		09:30 a.m.
14		10:30 a.m.
15		11:30 a.m.
16		01:30 p.m.
17		02:30p.m.
18		03:30 p.m.
19		04:30 p.m.
20		05:30 p.m.
21	5/10/2018	07:30 a.m.
22		08:30 a.m.

CLUSTER - XI [UNDER - 17] CBSE FOOTBALL TOURNAMENT 2018

FIXTURE

POOL – G

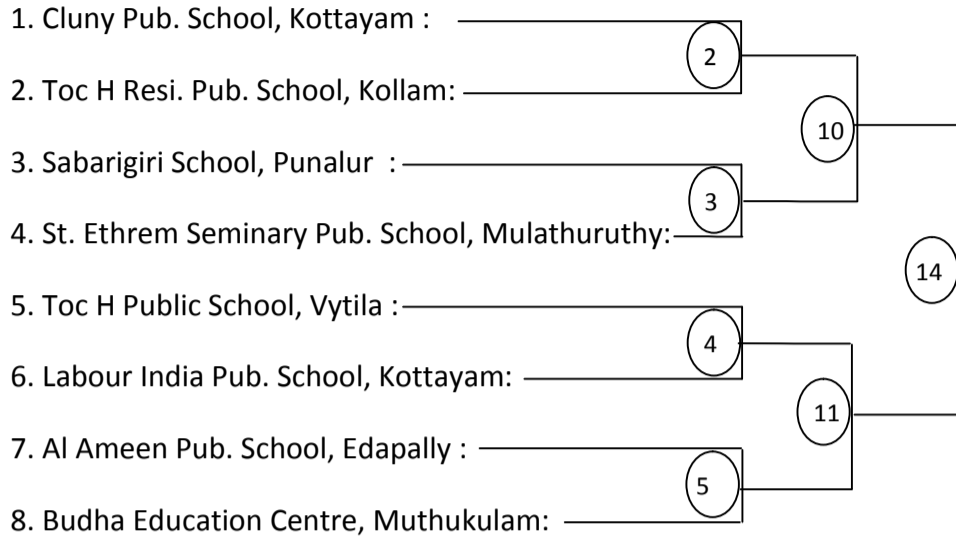

POOL – H

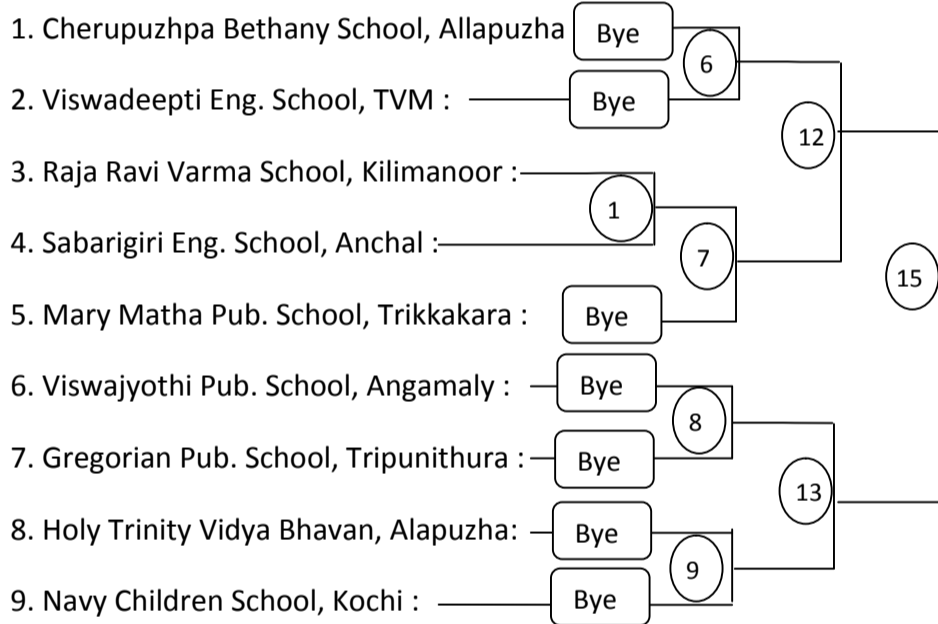

GROUND:		
B V M H.S , KALLETUMKARA, IRINJALAKUDA		
Match No:	Date	Time
1	3/10/2018	07:30 a.m.
2		08:30 a.m.
3		09:30 a.m.
4		10:30 a.m.
5		11:30 a.m.
6		01:30 p.m.
7		02:30p.m.
8		03:30 p.m.
9		04:30 p.m.
10		05:30 p.m.
11	4/10/2018	07:30 a.m.
12		08:30 a.m.
13		09:30 a.m.
14		10:30 a.m.
15		11:30 a.m.